

## FEATURES

- **LTC6908-1: Complementary Outputs (0°/180°)**
- **LTC6908-2: Quadrature Outputs (0°/90°)**
- **50kHz to 10MHz Frequency Range**
- **One External Resistor Sets the Frequency**
- **Optional Spread Spectrum Frequency Modulation for Improved EMC Performance**
- **±10% Frequency Spreading**
- 400µA Supply Current Typical ( $V^+ = 5V$ , 50kHz)
- Frequency Error  $\leq 1.5\%$  Max ( $T_A = 25^\circ C$ ,  $V^+ = 3V$ )
- $\pm 40$ ppm/ $^\circ C$  Temperature Stability
- Fast Start-Up Time: 260µs Typical (1MHz)
- Outputs Muted Until Stable
- Operates from a Single 2.7V to 5.5V Supply
- Available in Low Profile (1mm) ThinSOT and DFN (2mm x 3mm) Packages

## APPLICATIONS

- Switching Power Supply Clock Reference
- Portable and Battery-Powered Equipment
- Precision Programmable Oscillator
- Charge Pump Driver

## DESCRIPTION

The LTC<sup>®</sup>6908 is an easy-to-use precision oscillator that provides 2-outputs, shifted by either 180° or 90°. The oscillator frequency is programmed by a single external resistor ( $R_{SET}$ ) and spread spectrum frequency modulation (SSFM) can be activated for improved electromagnetic compatibility (EMC) performance.

The LTC6908 operates with a single 2.7V to 5.5V supply and provides rail-to-rail, 50% duty cycle square wave outputs. A single resistor from 10k to 2M is used to select an oscillator frequency from 50kHz to 10MHz (5V supply). The oscillator can be easily programmed using the simple formula outlined below:

$$f_{OUT} = 10MHz \cdot 10k/R_{SET}$$

The LTC6908's SSFM capability modulates the output frequency by a pseudorandom noise (PRN) signal to decrease the peak electromagnetic radiation level and improve EMC performance. The amount of frequency spreading is fixed at  $\pm 10\%$  of the center frequency. When SSFM is enabled, the rate of modulation is selected by the user. The three possible modulation rates are  $f_{OUT}/16$ ,  $f_{OUT}/32$  and  $f_{OUT}/64$ .

LT, LT, LTC and LTM are registered trademarks of Linear Technology Corporation. All other trademarks are the property of their respective owners.

## TYPICAL APPLICATION

2.25MHz, 2.5V/8A Step-Down Regulator

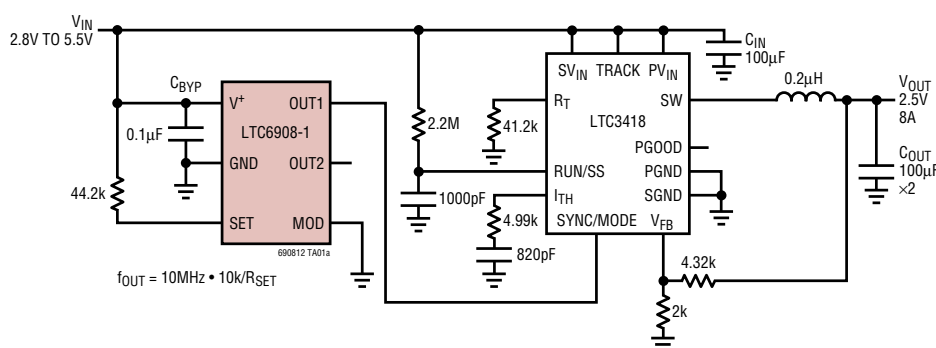

150kHz to 30MHz Output  
 Frequency Spectrum  
 (9kHz Res BW)

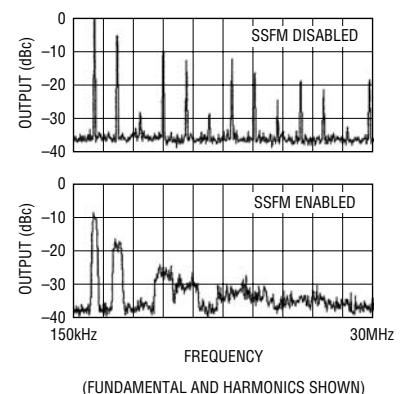

690812 TA01b  
 690812fa

# LTC6908-1/LTC6908-2

## ABSOLUTE MAXIMUM RATINGS

(Note 1)

Total Supply Voltage ( $V^+$ to GND) .....	6V
Maximum Voltage on any Pin ( $GND - 0.3V \leq V_{PIN} \leq (V^+ + 0.3V)$ )	
Output Short Circuit Duration .....	Indefinite
Operating Temperature Range (Note 2)	
LTC6908CS6-1/LTC6908CS6-2 .....	-40°C to 85°C
LTC6908IS6-1/LTC6908IS6-2 .....	-40°C to 85°C
LTC6908HS6-1/LTC6908HS6-2 .....	-40°C to 125°C
LTC6908CDCB-1/LTC6908CDCB-2 .....	-40°C to 85°C
LTC6908IDCB-1/LTC6908IDCB-2 .....	-40°C to 85°C

Specified Temperature Range (Note 3)

LTC6908CS6-1/LTC6908CS6-2 .....	0°C to 70°C
LTC6908IS6-1/LTC6908IS6-2 .....	-40°C to 85°C
LTC6908HS6-1/LTC6908HS6-2 .....	-40°C to 125°C
LTC6908CDCB-1/LTC6908CDCB-2 .....	0°C to 70°C
LTC6908IDCB-1/LTC6908IDCB-2 .....	-40°C to 85°C
Storage Temperature Range (S6) .....	-65°C to 150°C
Storage Temperature Range (DCB) .....	-65°C to 125°C
Lead Temperature (Soldering, 10sec) .....	300°C

## PACKAGE/ORDER INFORMATION

<p>TOP VIEW</p> <p>DCB PACKAGE 6-LEAD (2mm x 3mm) PLASTIC DFN <math>T_{JMAX} = 125^{\circ}C</math>, <math>\theta_{JA} = 64^{\circ}C/W</math> EXPOSED PAD (PIN 7) IS GND, MUST BE SOLDERED TO PCB</p>		<p>TOP VIEW</p> <p>S6 PACKAGE 6-LEAD PLASTIC TSOT-23 <math>T_{JMAX} = 150^{\circ}C</math>, <math>\theta_{JA} = 230^{\circ}C/W</math></p>	
ORDER PART NUMBER	DCB PART MARKING*	ORDER PART NUMBER	S6 PART MARKING*
LTC6908CDCB-1	LBXZ	LTC6908CS6-1	LTBYC
LTC6908IDCB-1	LBXZ	LTC6908IS6-1	LTBYC
LTC6908CDCB-2	LBYB	LTC6908HS6-1	LTBYC
LTC6908IDCB-2	LBYB	LTC6908CS6-2	LTBYD
		LTC6908IS6-2	LTBYD
		LTC6908HS6-2	LTBYD
<p><b>Order Options</b> Tape and Reel: Add #TR Lead Free: Add #PBF Lead Free Tape and Reel: Add #TRPBF Lead Free Part Marking: <a href="http://www.linear.com/leadfree/">http://www.linear.com/leadfree/</a></p>			

Consult LTC Marketing for parts specified with wider operating temperature ranges. \*The temperature grade is identified by a label on the shipping container.

**ELECTRICAL CHARACTERISTICS** The ● denotes the specifications which apply over the full operating temperature range, otherwise specifications are at  $T_A = 25^\circ\text{C}$ . Test conditions are  $V^+ = 2.7\text{V}$  to  $5.5\text{V}$ ,  $R_L = 5\text{k}$ ,  $C_L = 5\text{pF}$  unless otherwise noted. The modulation is turned off (MOD is connected to OUT2) unless otherwise specified.  $R_{\text{SET}}$  is defined as the resistor connected from the SET pin to the  $V^+$  pin.

SYMBOL	PARAMETER	CONDITIONS	MIN	TYP	MAX	UNITS
$\Delta f_{\text{OUT}}$	Frequency Accuracy (Note 4)	$V^+ = 2.7\text{V}$ $250\text{kHz} \leq f_{\text{OUT}} \leq 5\text{MHz}$ $250\text{kHz} \leq f_{\text{OUT}} \leq 5\text{MHz}$ $50\text{kHz} \leq f_{\text{OUT}} < 250\text{kHz}$	● ●	$\pm 0.5$ $\pm 2$ $\pm 2.5$	$\pm 1.5$ $\pm 2.5$ $\pm 3.5$	% % %
		$V^+ = 5\text{V}$ $250\text{kHz} \leq f_{\text{OUT}} \leq 5\text{MHz}$ $250\text{kHz} \leq f_{\text{OUT}} \leq 5\text{MHz}$ $50\text{kHz} \leq f_{\text{OUT}} < 250\text{kHz}$ $5\text{MHz} < f_{\text{OUT}} \leq 10\text{MHz}$	● ● ● ●	$\pm 1$ $\pm 2.5$ $\pm 3$ $\pm 3.5$	$\pm 2$ $\pm 3$ $\pm 4$ $\pm 4.5$	% % % %
$R_{\text{SET}}$	Frequency Setting Resistor Range	$V^+ = 2.7\text{V}$ $ \Delta f_{\text{OUT}}  \leq 1.5\%$ $ \Delta f_{\text{OUT}}  \leq 2.5\%$ $ \Delta f_{\text{OUT}}  \leq 3.5\%$	● ● ●	20 20 400	400 400 2000	k k k
		$V^+ = 5\text{V}$ $ \Delta f_{\text{OUT}}  \leq 2\%$ $ \Delta f_{\text{OUT}}  \leq 3\%$ $ \Delta f_{\text{OUT}}  \leq 4\%$ $ \Delta f_{\text{OUT}}  \leq 4.5\%$	● ● ● ●	20 20 400 10	400 400 2000 20	k k k k
$\Delta f_{\text{OUT}}/\Delta T$	Frequency Drift Over Temperature	$R_{\text{SET}} = 100\text{k}$	●	$\pm 0.004$		%/ $^\circ\text{C}$
$\Delta f_{\text{OUT}}/\Delta V^+$	Frequency Drift Over Supply (Note 4)	$V^+ = 2.7\text{V}$ to $3.6\text{V}$ , $R_{\text{SET}} = 100\text{k}$ $V^+ = 4.5\text{V}$ to $5.5\text{V}$ , $R_{\text{SET}} = 100\text{k}$	● ●	0.04 0.4	0.25 0.9	%/ $V$ %/ $V$
		Period Variation (Frequency Spreading)	$R_{\text{SET}} = 100\text{k}$ , MOD Pin = $V^+$ , GND or OPEN	●	$\pm 7.5$ $\pm 10$ $\pm 12.5$	
	Long-Term Stability of Output Frequency (Note 8)			300		ppm/ $\sqrt{\text{kHr}}$
	Duty Cycle (Note 5)	No Modulation, $250\text{kHz} \leq f_{\text{OUT}} \leq 1\text{MHz}$	●	45 50 55		%
$V^+$	Operating Supply Range		●	2.7	5.5	V
$I_S$	Power Supply Current	$R_{\text{SET}} = 2000\text{k}$ , $R_L = \infty$ , $f_{\text{OUT}} = 50\text{kHz}$ , MOD Pin = $V^+$ $V^+ = 5\text{V}$ $V^+ = 2.7\text{V}$	● ●	0.4 0.4	0.65 0.6	mA mA
		$R_{\text{SET}} = 20\text{k}$ , $R_L = \infty$ , $f_{\text{OUT}} = 5\text{MHz}$ , MOD Pin = GND $V^+ = 5\text{V}$ $V^+ = 2.7\text{V}$	● ●	1.25 0.9	1.7 1.3	mA mA
$V_{\text{IH\_MOD}}$	High Level MOD Input Voltage		●	$V^+ - 0.4$		V
$V_{\text{IL\_MOD}}$	Low Level MOD Input Voltage		●		0.4	V
$I_{\text{MOD}}$	MOD Pin Input Current (Note 6)	MOD Pin = $V^+$ , $V^+ = 5\text{V}$ MOD Pin = GND, $V^+ = 5\text{V}$	● ●	2 -4	4	$\mu\text{A}$ $\mu\text{A}$
		$V^+ = 5\text{V}$ $I_{\text{OH}} = -0.3\text{mA}$ $I_{\text{OH}} = -1.2\text{mA}$	● ●	4.75 4.4	4.9 4.7	V V
$V_{\text{OH}}$	High Level Output Voltage (Note 6) (OUT1, OUT2)	$V^+ = 2.7\text{V}$ $I_{\text{OH}} = -0.3\text{mA}$ $I_{\text{OH}} = -0.8\text{mA}$	● ●	2.35 1.85	2.6 2.2	V V
		$V^+ = 5\text{V}$ $I_{\text{OL}} = 0.3\text{mA}$ $I_{\text{OL}} = 1.2\text{mA}$	● ●	0.05 0.2	0.15 0.5	V V
$V_{\text{OL}}$	Low Level Output Voltage (Note 6)	$V^+ = 2.7\text{V}$ $I_{\text{OL}} = 0.3\text{mA}$ $I_{\text{OL}} = 0.8\text{mA}$	● ●	0.1 0.4	0.3 0.7	V V
		$V^+ = 5\text{V}$ $V^+ = 2.7\text{V}$		6 11		ns ns
$t_r$	Output Rise Time (Note 7)			5 9		ns ns
$t_f$	Output Fall Time (Note 7)					

## ELECTRICAL CHARACTERISTICS

**Note 1:** Stresses beyond those listed under Absolute Maximum Ratings may cause permanent damage to the device. Exposure to any Absolute Maximum Rating condition for extended periods may affect device reliability and lifetime.

**Note 2:** LTC6908C and LTC6908I are guaranteed functional over the operating temperature range of  $-40^{\circ}\text{C}$  to  $85^{\circ}\text{C}$ .

**Note 3:** LTC6908C is guaranteed to meet specified performance from  $0^{\circ}\text{C}$  to  $70^{\circ}\text{C}$ . The LTC6908C is designed, characterized and expected to meet specified performance from  $-40^{\circ}\text{C}$  to  $85^{\circ}\text{C}$  but is not tested or QA sampled at these temperatures. The LTC6908I is guaranteed to meet the specified performance limits from  $-40^{\circ}\text{C}$  to  $85^{\circ}\text{C}$ . The LTC6908H is guaranteed to meet the specified performance limits from  $-40^{\circ}\text{C}$  to  $125^{\circ}\text{C}$ .

**Note 4:** Frequency accuracy is defined as the deviation from the  $f_{\text{OUT}}$  equation.

**Note 5:** Guaranteed by 5V test

**Note 6:** To conform to the Logic IC Standard, current out of a pin is arbitrarily given a negative value.

**Note 7:** Output rise and fall times are measured between the 10% and the 90% power supply levels with no output loading. These specifications are based on characterization.

**Note 8:** Long term drift on silicon oscillators is primarily due to the movement of ions and impurities within the silicon and is tested at  $30^{\circ}\text{C}$  under otherwise nominal operating conditions. Long term drift is specified as  $\text{ppm}/\sqrt{\text{kHr}}$  due to the typically non-linear nature of the drift. To calculate drift for a set time period, translate that time into thousands of hours, take the square root and multiply by the typical drift number. For instance, a year is 8.77kHr and would yield a drift of 888ppm at  $300\text{ppm}/\sqrt{\text{kHr}}$ . Ten years is 87.7kHr and would yield a drift of 2,809 ppm at  $300\text{ppm}/\sqrt{\text{kHr}}$ . Drift without power applied to the device may be approximated as 1/10th of the drift with power, or  $30\text{ppm}/\sqrt{\text{kHr}}$  for a  $300\text{ppm}/\sqrt{\text{kHr}}$  device.

## TYPICAL PERFORMANCE CHARACTERISTICS

Frequency Error vs  $R_{\text{SET}}$ ,  
 $V^+ = 3\text{V}$

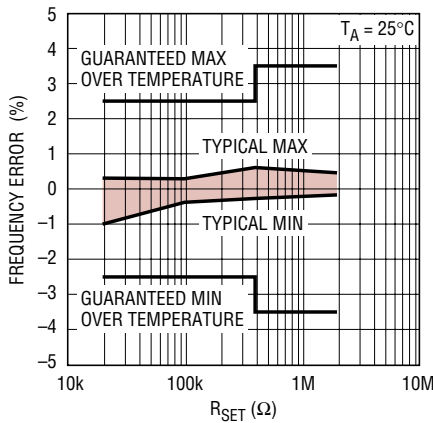

Frequency Error vs  $R_{\text{SET}}$ ,  
 $V^+ = 5\text{V}$

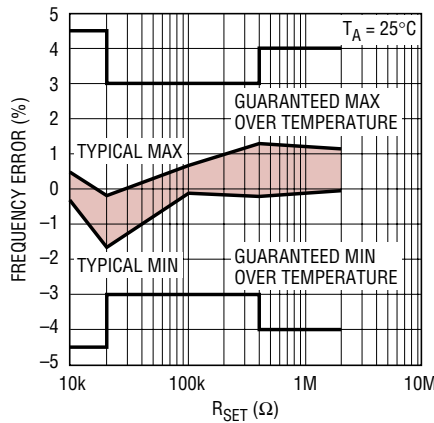

Frequency Error vs Temperature

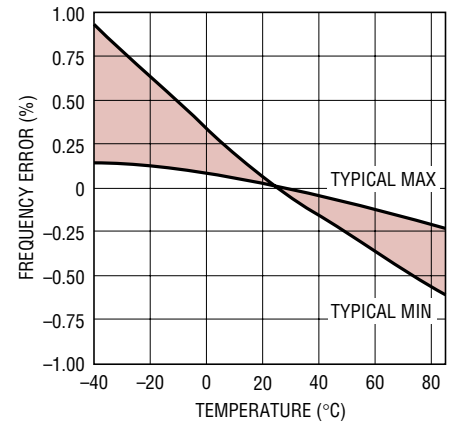

Peak to Peak Jitter vs Output Frequency

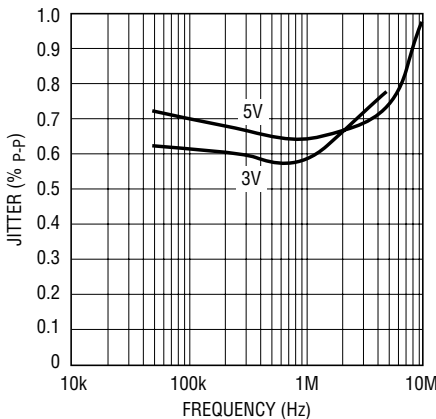

Supply Current vs Output Frequency

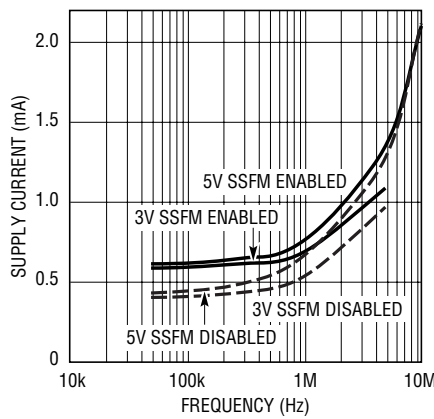

Supply Current vs Temperature

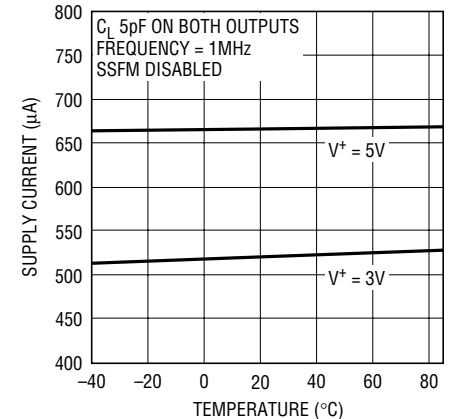

# TYPICAL PERFORMANCE CHARACTERISTICS

**Output Resistance vs Supply Voltage**

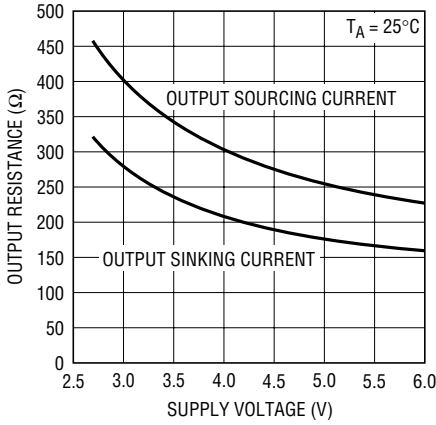

**Output Operating at 5MHz,  $V^+ = 3V$**

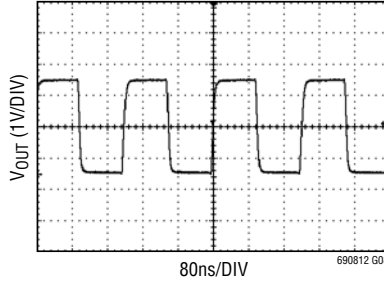

**Output Operating at 10MHz,  $V^+ = 5V$**

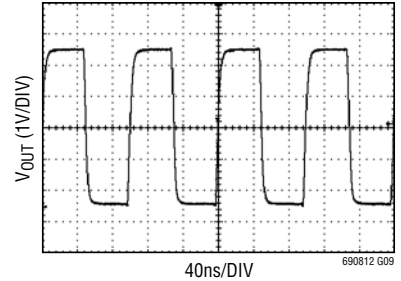

**Output Frequency Spectrum with SSFM Enabled and Disabled**

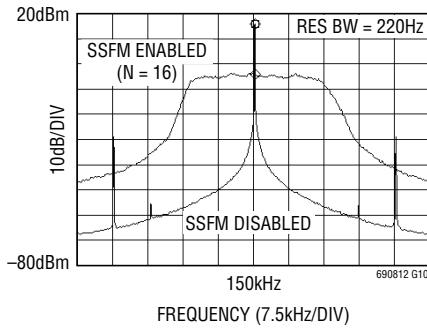

**Output Frequency Spectrum with SSFM Enabled and Disabled**

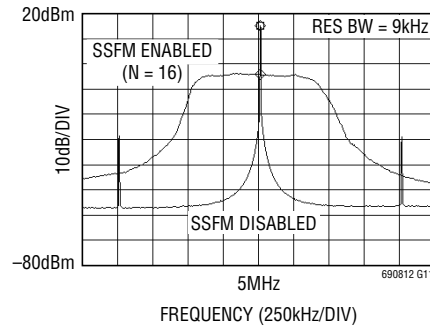

## PIN FUNCTIONS (DCB Package/S6 Package)

**SET (Pin 1/Pin 3):** Frequency-Setting Resistor Input. The value of the resistor connected between this pin and  $V^+$  determines the oscillator frequency. The voltage on this pin is held by the LTC6908 to approximately 1.1V below the  $V^+$  voltage. For best performance, use a precision metal film resistor with a value between 20k and 400k and limit the capacitance on this pin to less than 10pF.

**$V^+$  (Pin 2/Pin 1):** Voltage Supply ( $2.7V \leq V^+ \leq 5.5V$ ). This supply must be kept free from noise and ripple. It should be bypassed directly to a ground plane with a  $0.1\mu F$  capacitor.

**GND (Pin 3/Pin 2):** Ground. Should be tied to a ground plane for best performance.

**OUT1 (Pin 4/Pin 6), OUT2 (Pin 5/Pin 5):** Oscillator Outputs. These pins can drive 5k and/or 10pF loads. Larger loads may cause inaccuracies due to supply bounce at high frequencies.

**MOD (Pin 6/Pin 4):** Modulation-Setting Input. This three-state input selects among four modulation rate settings. The MOD pin should be tied to ground for the  $f_{OUT}/16$  modulation rate. Floating the MOD pin selects the  $f_{OUT}/32$  modulation rate. The MOD pin should be tied to  $V^+$  for the  $f_{OUT}/64$  modulation rate. Tying one of the outputs to the MOD pin turns the modulation off. To detect a floating MOD pin, the LTC6908 attempts to pull the pin toward midsupply. This is realized with two internal current sources, one tied to  $V^+$  and MOD and the other one tied to ground and MOD. Therefore, driving the MOD pin high requires sourcing approximately  $2\mu A$ . Likewise, driving the MOD pin low requires sinking  $2\mu A$ . When the MOD pin is floated, it must be bypassed by a 1nF capacitor to ground. Any AC signal coupling to the MOD pin could potentially be detected and stop the frequency modulation.

**Exposed Pad (Pin 7/NA):** Ground. The Exposed Pad must be soldered to PCB.

## BLOCK DIAGRAM (S6 Package Pin Numbers)

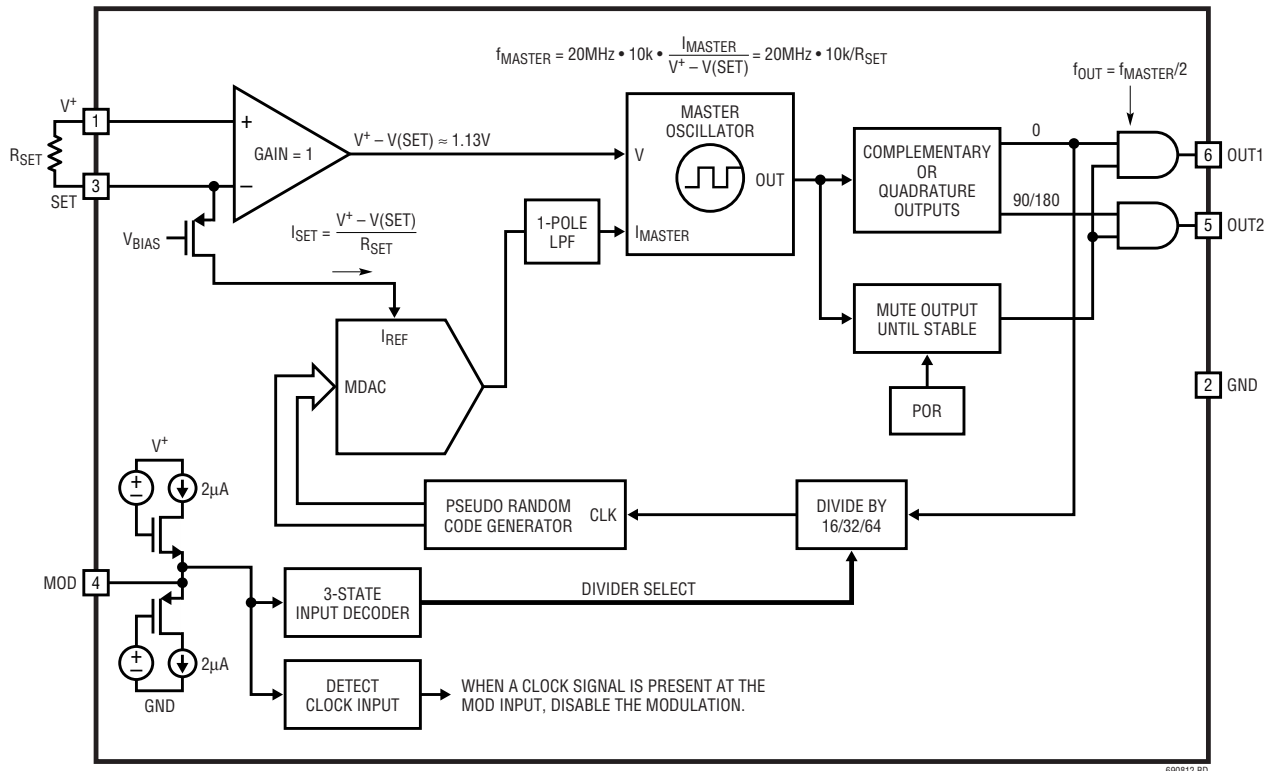

## OPERATION

As shown in the Block Diagram, the LTC6908's master oscillator is controlled by the ratio of the voltage between the  $V^+$  and SET pins and the current entering the SET pin ( $I_{MASTER}$ ). When the spread spectrum frequency modulation (SSFM) is disabled,  $I_{MASTER}$  is strictly determined by the  $(V^+ - V_{SET})$  voltage and the  $R_{SET}$  resistor. When SSFM is enabled,  $I_{MASTER}$  is modulated by a filtered pseudorandom noise (PRN) signal. Here the  $I_{MASTER}$  current is a random value uniformly distributed between  $(I_{SET} - 10\%)$  and  $(I_{SET} + 10\%)$ . In this way the frequency of the master oscillator is modulated to produce an approximately flat frequency spectrum that is centered at the frequency set by the  $I_{SET}$  current, with a bandwidth equal to approximately 20% of the center frequency.

The voltage on the SET pin is forced to approximately 1.1V below  $V^+$  by the PMOS transistor and its gate bias voltage. This voltage is accurate to  $\pm 5\%$  at a particular input current and supply voltage (see Figure 1). The LTC6908 is optimized for use with resistors between 20k and 400k, corresponding to output frequencies between 250kHz and 5MHz. Accurate frequencies up to 10MHz ( $R_{SET} = 10k$ ) are attainable if the supply voltage is greater than 4V. The  $R_{SET}$  resistor, connected between the  $V^+$  and SET pins, locks together the  $(V^+ - V_{SET})$  voltage and the current  $I_{SET}$ . This allows the parts to attain excellent frequency accuracy regardless of the precision of the SET pin voltage. The master oscillation frequency is:

$$f_{MASTER} = 20MHz \cdot 10k/R_{SET}$$

The master oscillator signal is divided by 2 before driving the output pins, resulting in the simple formula for the

output frequency,  $f_{OUT}$ , below (see Figure 2):

$$f_{OUT} = 10MHz \cdot 10k/R_{SET}$$

When the spread spectrum frequency modulation (SSFM) is disabled, the frequency  $f_{OUT}$  is the final output frequency. When SSFM is enabled,  $0.9 \cdot f_{OUT}$  is the minimum output frequency and  $1.1 \cdot f_{OUT}$  is the maximum output frequency.

Both outputs are nominally 50% duty cycle. There are 2 possible output configurations for the LTC6908, shown in Figure 3.

### Output Configurations

The only difference between the two versions of the LTC6908 is the phase relationship between the two outputs. The LTC6908-1 outputs are 180 degrees out of phase and the LTC6908-2 outputs are 90 degrees out of phase. These convenient output options are useful in synchronizing the clocking of multiple phase switching regulator designs. In very high current applications, a significant improvement

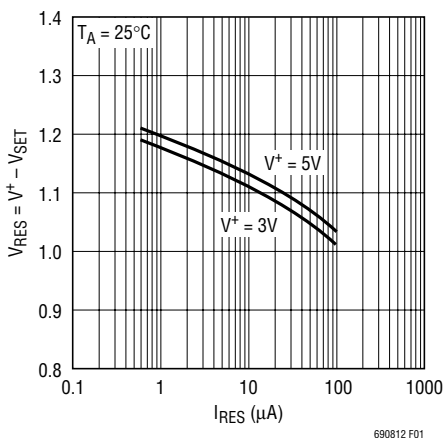

Figure 1.  $V^+ - V_{SET}$  Variation with  $I_{RES}$

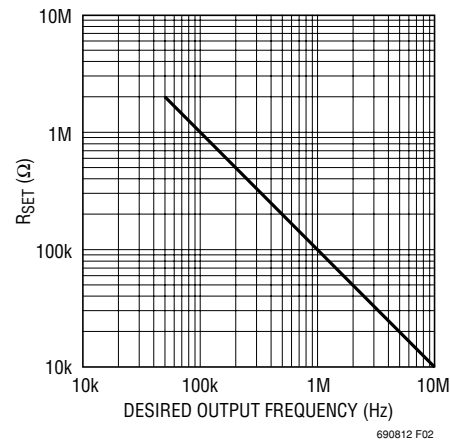

Figure 2.  $R_{SET}$  vs Desired Output Frequency

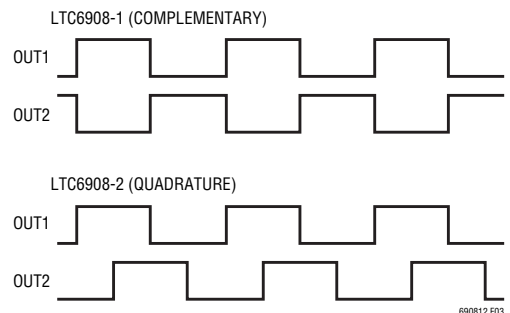

Figure 3. Output Waveforms for LTC6908-1, LTC6908-2

## OPERATION

in conducted EMI results due to the reduced levels of input and output ripple currents. The LTC6908-1 is ideal for use with two single output switching regulators. The quadrature outputs of the LTC6908-2, together with two dual output switching regulators, provide the 0°, 90°, 180° and 270° phased shifted clocks for four-phase control.

The rise and fall times are typically 6ns with a 5V supply and 11ns with a 3V supply. An internal counter mutes the outputs for the first 64 clock cycles after power-up, ensuring that the first clock cycle is close to the desired operating frequency.

### Spread Spectrum Frequency Modulation

The LTC6908 provides the additional feature of spread spectrum frequency modulation (SSFM). The oscillator's frequency is modulated by a pseudorandom noise (PRN) signal to spread the oscillator's energy over a wide frequency band. This spreading decreases the peak electromagnetic radiation levels and improves electromagnetic compatibility (EMC) performance.

The amount of frequency spreading is fixed at 20% ( $\pm 10\%$ ), where frequency spreading is defined as:

$$\text{Frequency Spreading (in \%)} = 100 \cdot (f_{\text{MAX}} - f_{\text{MIN}})/f_{\text{OUT}}$$

The  $I_{\text{MASTER}}$  current is a dynamic signal generated by a multiplying digital to analog converter (MDAC) referenced to  $I_{\text{SET}}$  and lowpass filtered.  $I_{\text{MASTER}}$  varies in a pseudorandom noise-like manner between  $0.9 \cdot I_{\text{SET}}$  and  $1.1 \cdot I_{\text{SET}}$ . This causes the output frequency to vary in a pseudorandom noise-like manner between  $0.9 \cdot f_{\text{OUT}}$  and  $1.1 \cdot f_{\text{OUT}}$ .

To disable the SSFM, connect one of the outputs to the MOD pin. An AC detector circuit shuts down the modulation circuitry if a frequency in the vicinity of the output frequency is detected at the MOD pin.

As stated previously, the modulating waveform is a pseudorandom noise-like waveform. The pseudorandom signal is generated by a linear feedback shift register that is 15 bits long. The pseudorandom sequence will repeat every  $(2^{15} - 1) \cdot N$  clock cycles. This guarantees a repetition rate below 20Hz for output frequencies up to 10MHz. Seven bits of the shift register are sent in parallel to the MDAC which produces the modulating current waveform. Being a digitally generated signal, the output of the MDAC is not a perfectly smooth waveform, but consists of  $(2^7)$  discrete steps that change every shift register clock cycle. Note that the shift register clock is the output frequency,  $f_{\text{OUT}}$ , divided by N, where N is the modulation rate divider setting, which is determined by the state of the MOD pin. The MOD pin should be tied to ground for the N = 16 setting. Floating the MOD pin selects N = 32. The MOD pin should be tied to  $V^+$  for the N = 64 setting.

The output of the MDAC is then filtered by a lowpass filter with a corner frequency set to the modulation rate ( $f_{\text{OUT}}/N$ ). This limits the frequency change rate and softens corners of the waveform, but allows the waveform to fully settle at each frequency step. The rise and fall times of this single pole filter are approximately  $0.35/f_{\text{CORNER}}$ . This is beneficial when the LTC6908 is used to clock switching regulators as will be discussed in the Applications Information section. Figure 4 illustrates how the output frequency varies over time.

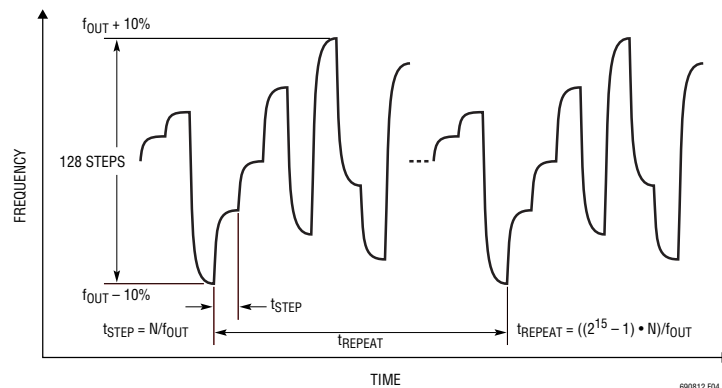

Figure 4



## APPLICATIONS INFORMATION

### SELECTING THE FREQUENCY-SETTING RESISTOR

The LTC6908 has an output frequency range spanning 50kHz to 10MHz. However, accuracy may suffer if the oscillator is operated at a frequency greater than 5MHz with a supply voltage lower than 4V. With a linear relationship correspondence between oscillation period and resistance, a simple equation relates resistance with frequency.

$$R_{SET} = 10k \cdot 10MHz / f_{OUT}$$

$$R_{SETMIN} = 10k \text{ (5V supply)}, 20k \text{ (3V supply)},$$

$$R_{SETMAX} = 2M$$

Any resistor,  $R_{SET}$ , tolerance will shift the output frequency,  $f_{OUT}$ .

### ALTERNATIVE METHODS OF SETTING THE OUTPUT FREQUENCY OF THE LTC6908

The oscillator may be programmed by any method that sources a current into the SET pin. The circuit in Figure 5 sets the oscillator frequency using a programmable current source and in the expression for  $f_{OUT}$ , the resistor  $R_{SET}$  is replaced by the ratio of  $1.1V/I_{CONTROL}$ . As already explained in the Operation section, the voltage difference between  $V^+$  and SET is approximately  $1.1V \pm 5\%$ , therefore, the Figure 5 circuit is less accurate than if a resistor controls the output frequency.

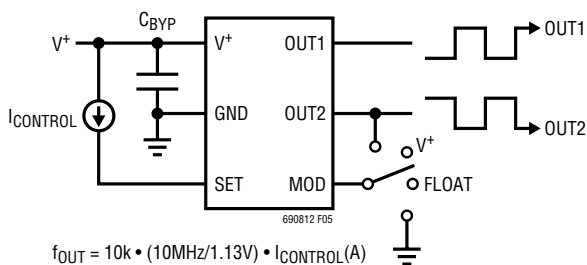

Figure 5. Current Controlled Oscillator

Figure 6 shows the LTC6908 configured as a VCO. A voltage source is connected in series with an external 10k resistor. The output frequency,  $f_{OUT}$ , will vary with  $V_{CONTROL}$ , that is the voltage source connected between  $V^+$  and the SET pin. Again, this circuit decouples the relationship between the input current and the voltage between  $V^+$

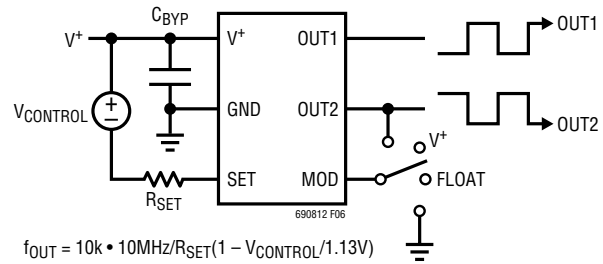

Figure 6. Voltage Controlled Oscillator

and SET; the frequency accuracy will be degraded. The oscillator frequency, however, will increase monotonically with decreasing  $V_{CONTROL}$ .

### SETTING THE MODULATION RATE OF THE LTC6908

The modulation rate of the LTC6908 is equal to  $f_{OUT}/N$ , where  $N$  is the modulation rate divider setting, which is determined by the state of the MOD pin. The MOD pin should be tied to ground for the  $N = 16$  setting. Floating the MOD pin selects  $N = 32$ . The MOD pin should be tied to  $V^+$  for the  $N = 64$  setting. To disable the SSFM, connect one of the outputs to the MOD pin. An AC detector circuit shuts down the modulation circuitry if a frequency that is close to the output frequency is detected at the MOD pin.

### DRIVING LOGIC CIRCUITS

The outputs of the LTC6908 are suitable for driving general digital logic circuits. However, the form of frequency spreading used in the LTC6908 may not be suitable for many logic designs. Many logic designs have fairly tight timing and cycle-to-cycle jitter requirements. These systems often benefit from a spread spectrum clocking system where the frequency is slowly and linearly modulated by a triangular waveform, not a pseudorandom waveform. This type of frequency spreading maintains a minimal difference in the timing from one clock edge to the next adjacent clock edge (cycle-to-cycle jitter). The LTC6908 uses a pseudorandom modulating signal where the frequency transitions have been slowed and the corners rounded by a first order lowpass filter with a corner frequency set to the modulation rate ( $f_{OUT}/N$ ), where  $N$  is the modulation rate divider setting, which is determined by the state

## APPLICATIONS INFORMATION

of the MOD pin. This filtered modulating signal may be acceptable for many logic systems but the cycle-to-cycle jitter issues must be considered carefully.

### DRIVING SWITCHING REGULATORS

The LTC6908 is designed primarily to provide an accurate and stable clock for switching regulator systems. The complementary (LTC6908-1) or quadrature (LTC6908-2) CMOS logic outputs are suitable for directly driving most switching regulators and switching controllers. Linear Technology has a broad line of fully integrated switching regulators and switching regulator controllers designed for synchronization to an external clock. All of these parts have one pin assigned for external clock input. The nomenclature varies depending on the part's family history. SYNC, PLLIN, SYNC/MODE, SHDN, EXTCLK, FCB and S/S (shorthand for SYNC/SHDN) are examples of clock input pin names used with Linear Technology ICs.

For the best EMC performance, the LTC6908 should be run with the MOD pin tied to ground (SSFM enabled, modulation rate set to  $f_{OUT}/16$ ). Regulatory testing is done with strictly specified bandwidths and conditions. Modulating faster than the test bandwidth or as close to the bandwidth as possible gives the lowest readings. The optimal modulating rate is not as straightforward when the goal is to lower radiated signal levels interfering with other circuitry in the system. The modulation rate will have to be evaluated with the specific system conditions to determine the optimal rate. Depending on the specific frequency synchronization method a switching regulator employs, the modulation rate must be within the synchronization capability of the regulator. Many regulators use a phase-locked loop (PLL) for synchronization. For these parts, the PLL loop filter should be designed to have sufficient capture range and bandwidth.

The frequency hopping transitions of the LTC6908 are slowed by a lowpass filter. The corner frequency of this filter is set to the modulation rate ( $f_{OUT}/N$ ), where N is the modulation rate divider setting, which is determined by the state of the MOD pin. The MOD pin should be tied

to ground for the N = 16 setting. Floating the MOD pin selects N = 32. The MOD pin should be tied to V<sup>+</sup> for the N = 64 setting. This is an important feature when driving a switching regulator. The switching regulator is itself a servo loop with a bandwidth typically on the order of 1/10, but can vary from 1/50 to 1/2 of the operating frequency. When the clock frequency's transition is within the bandwidth of the switching regulator, the regulator's output stays in regulation. If the transition is too sharp, beyond the bandwidth of the switching regulator, the regulator's output will experience a sharp jump and then settle back into regulation. If the bandwidth of the regulator is sufficiently high, beyond  $f_{OUT}/N$ , then there will not be any regulation issues.

One aspect of the output voltage that will change is the output ripple voltage. Every switching regulator has some output ripple at the clock frequency. For most switching regulator designs with fixed MOSFET's, fixed inductor, fixed capacitors, the amount of ripple will vary some with the regulators operating frequency (the main exception being hysteretic architecture regulators). An increase in frequency results in lower ripple and a frequency decrease gives more ripple. This is true for static frequencies or dynamic frequency modulated systems. If the modulating signal was a triangle wave, the regulator's output would have a ripple that is amplitude modulated by the triangle wave. This repetitive signal on the power supply could cause system problems by mixing with other desired signals creating distortion. Depending on the inductor design and triangle wave frequency, it may even result in an audible noise. The LTC6908 uses a pseudorandom noise-like signal. On an oscilloscope, it looks essentially noise-like of even amplitude. The signal is broadband and any mixing issues are eliminated. Additionally, the pseudorandom signal repeats at such a low rate that it is well below the audible range.

The LTC6908 directly drives many switching regulators. The LTC6908 with the spread spectrum frequency modulation results in improved EMC performance. If the bandwidth of the switching regulator is sufficient, not a difficult requirement in most cases, the regulator's regulation, efficiency

## APPLICATIONS INFORMATION

and load response are maintained while peak electromagnetic radiation (or conduction) is reduced. Output ripple may be somewhat increased, but its behavior is very much like noise and its system impact is benign.

### HIGH FREQUENCY REJECTION

Using the LTC6908 in spread spectrum mode naturally eliminates any concerns for output frequency accuracy and stability as it is continually hopping to new settings. In fixed frequency applications however, some attention to  $V^+$  supply voltage ripple is required to minimize additional output frequency error. Ripple frequency components on the supply line near the programmed output frequency of the LTC6908 in excess of  $30\text{mV}_{\text{P-P}}$  could create an additional 0.2% of frequency error. In applications where a fixed frequency LTC6908 output clock is used to synchronize the same switching regulator that provides the  $V^+$  supply to the oscillator, noticeable jitter of the clock may occur if the ripple exceeds  $30\text{mV}_{\text{P-P}}$ .

### START-UP TIME

The start-up time and settling time to within 1% of the final value can be estimated by  $t_{\text{START}} \approx R_{\text{SET}} \cdot (2.5\mu\text{s}/\text{k}) + 10\mu\text{s}$ . For instance, with  $R_{\text{SET}} = 100\text{k}$ , the LTC6908 will settle to within 1% of its 1MHz final value in approximately  $260\mu\text{s}$ .

Figure 7 shows start-up times for various  $R_{\text{SET}}$  resistors. An internal counter mutes the outputs for the first 64 clock cycles after power-up, ensuring that the first clock cycle is close to the desired operating frequency.

### JITTER

The Peak-to-Peak Jitter vs Output Frequency graph, in the Typical Performance Characteristics section, shows the typical clock jitter as a function of oscillator frequency and power supply voltage. These specifications assume that the capacitance on SET is limited to less than  $10\text{pF}$ , as suggested in the Pin Functions description. If this requirement is not met, the jitter will increase.

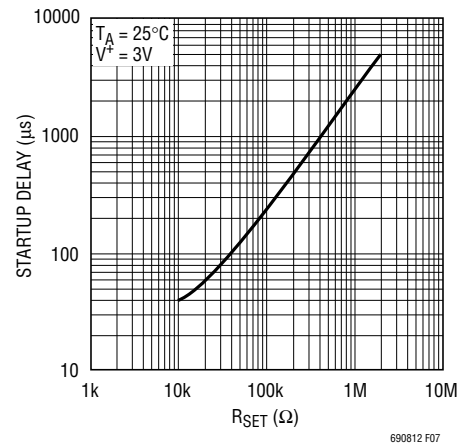

Figure 7. Start-Up Time

## TYPICAL APPLICATIONS

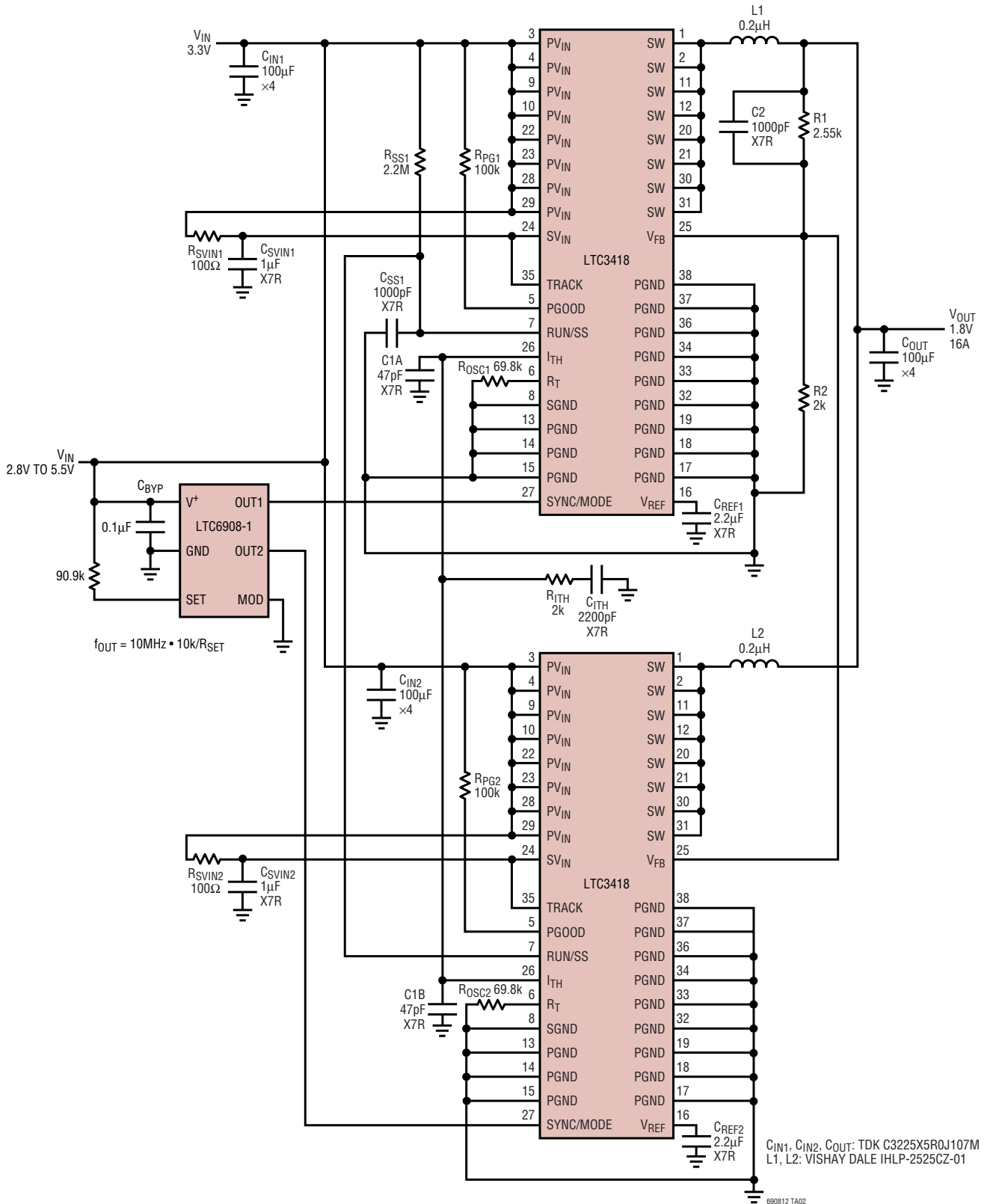
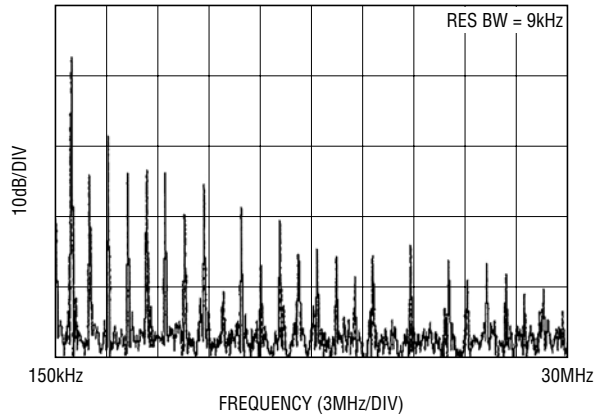
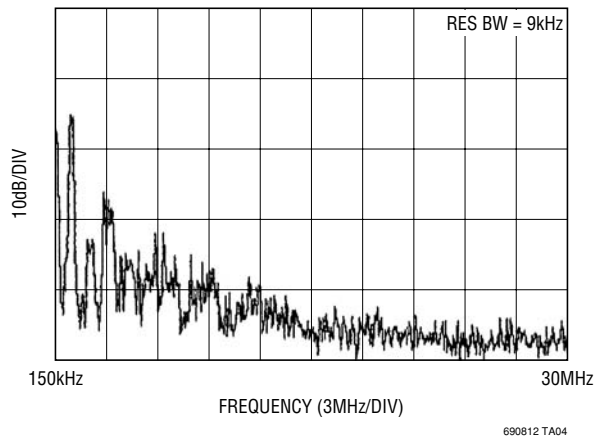

Figure 8a. 1.1MHz, 1.8V/16A Step-Down Regulator

**TYPICAL APPLICATIONS**



**Figure 8b. Output Frequency Spectrum of Two-Phase Regulator, Figure 8a, with SSFM Disabled**



**Figure 8c. Output Frequency Spectrum of Two-Phase Regulator, Figure 8a, with SSFM Enabled**

# PACKAGE DESCRIPTION

**DCB Package**  
**6-Lead Plastic DFN (2mm × 3mm)**  
 (Reference LTC DWG # 05-08-1715)

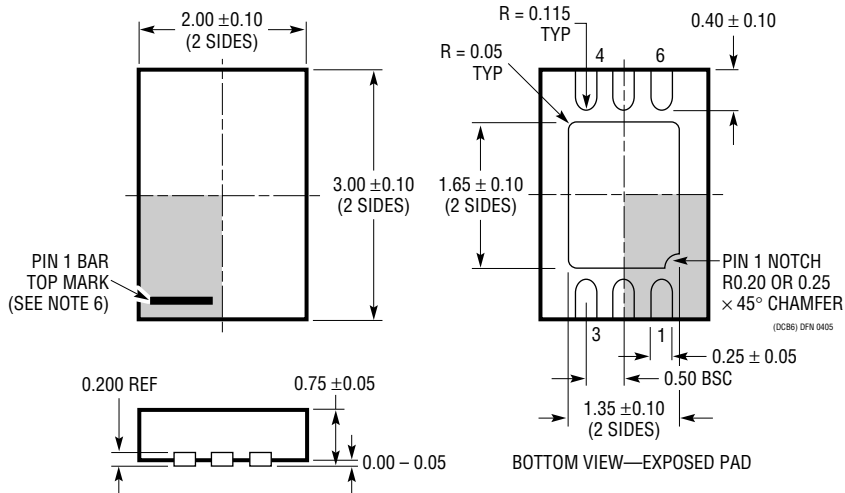
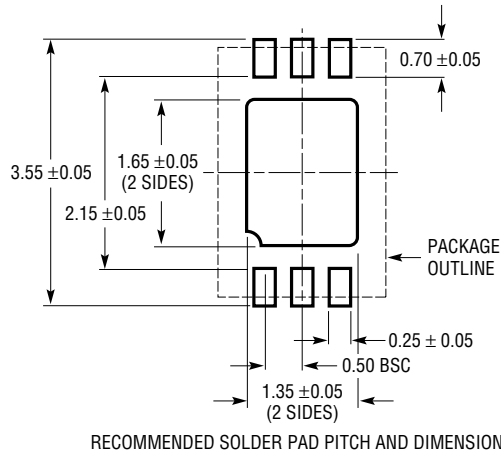

- NOTE:
1. DRAWING TO BE MADE A JEDEC PACKAGE OUTLINE M0-229 VARIATION OF (TBD)
  2. DRAWING NOT TO SCALE
  3. ALL DIMENSIONS ARE IN MILLIMETERS
  4. DIMENSIONS OF EXPOSED PAD ON BOTTOM OF PACKAGE DO NOT INCLUDE MOLD FLASH. MOLD FLASH, IF PRESENT, SHALL NOT EXCEED 0.15mm ON ANY SIDE
  5. EXPOSED PAD SHALL BE SOLDER PLATED
  6. SHADED AREA IS ONLY A REFERENCE FOR PIN 1 LOCATION ON THE TOP AND BOTTOM OF PACKAGE

# PACKAGE DESCRIPTION

**S6 Package**  
**6-Lead Plastic TSOT-23**  
 (Reference LTC DWG # 05-08-1636)

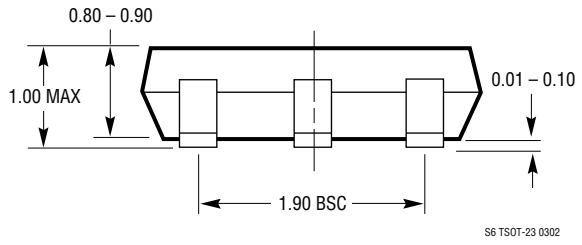
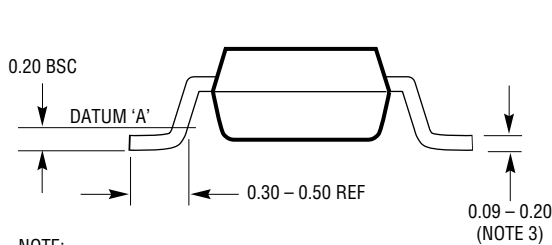
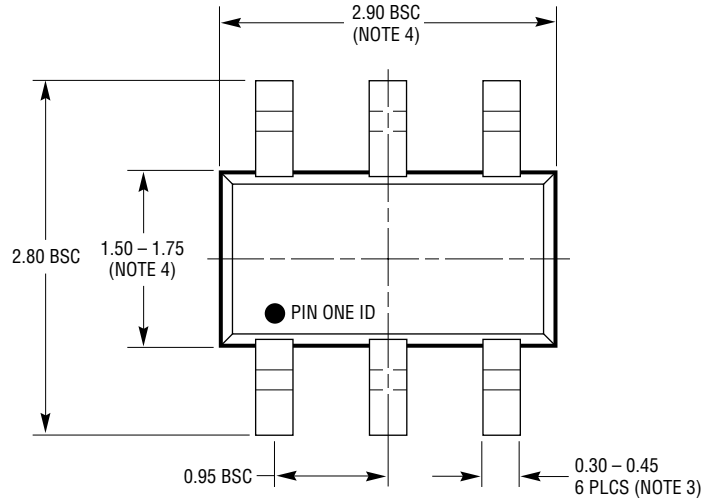
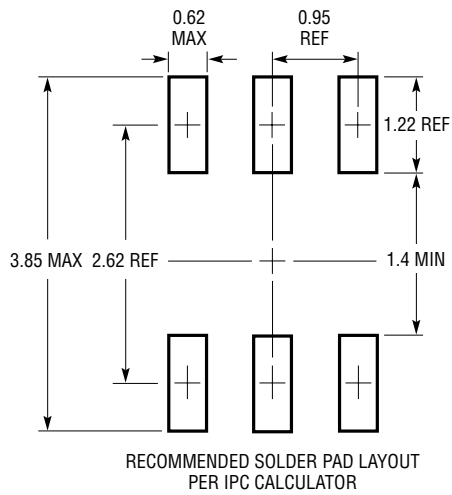

- NOTE:
1. DIMENSIONS ARE IN MILLIMETERS
  2. DRAWING NOT TO SCALE
  3. DIMENSIONS ARE INCLUSIVE OF PLATING
  4. DIMENSIONS ARE EXCLUSIVE OF MOLD FLASH AND METAL BURR
  5. MOLD FLASH SHALL NOT EXCEED 0.254mm
  6. JEDEC PACKAGE REFERENCE IS MO-193

## TYPICAL APPLICATION

Quick Evaluation Circuit for Effects Of Frequency Spreading Modulation Rate. (DFN Package Demo Board DC814D-J/K)

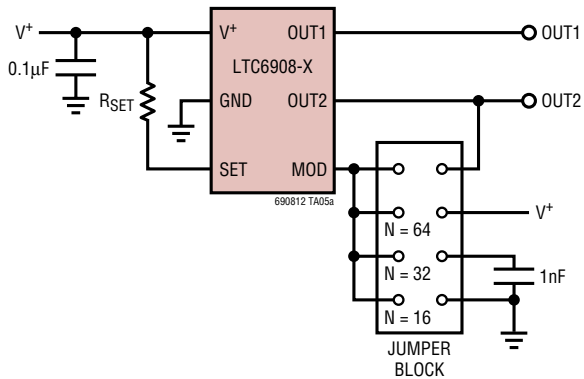

Doubling the Output Frequency

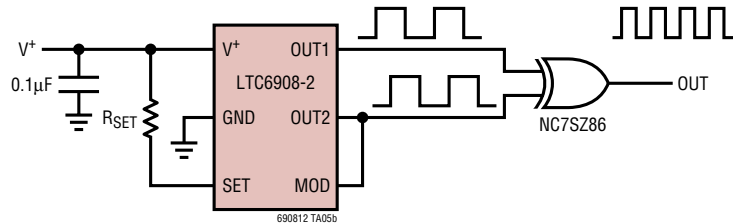

## RELATED PARTS

PART NUMBER	DESCRIPTION	COMMENTS
LTC1799	1kHz to 33MHz ThinSOT Oscillator, Resistor Set	Wide Frequency Range
LTC6900	1kHz to 20MHz ThinSOT Oscillator, Resistor Set	Low Power, Wide Frequency Range
LTC6902	Multiphase Oscillator with Spread Spectrum Modulation	2-, 3-, or 4-Phase Outputs
LTC6903/LTC6904	1kHz to 68MHz Serial Port Programmable Oscillator	0.1% Frequency Resolution, I <sup>2</sup> C or SPI Interface
LTC6905	17MHz to 170MHz ThinSOT Oscillator, Resistor Set	High Frequency, 100µs Startup, 7ps RMS Jitter
LTC6905-XXX	Fixed Frequency ThinSOT Oscillators, Up to 133MHz	No Trim Components Required
LTC6906/LTC6907	Micropower ThinSOT Oscillator, Resistor Set	10kHz to 1MHz or 40kHz to 4MHz, 36µA at 400kHz